

RoHS Compliant

REV.	Revision note	Date	Signature	Checked
1.0	Release to product	13/04/08	Pillar	

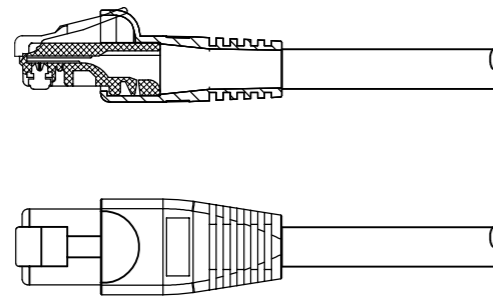
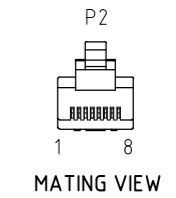
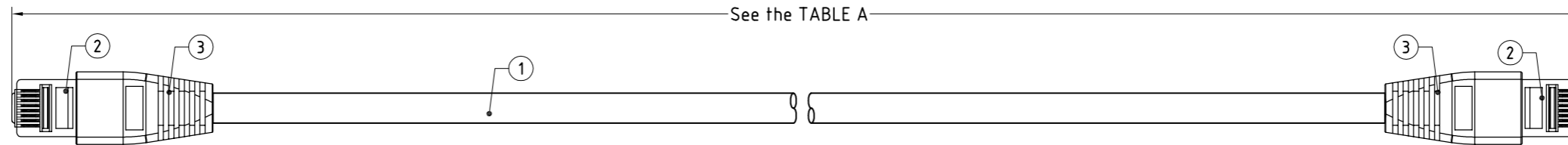
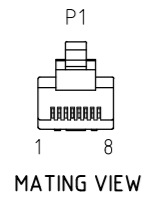
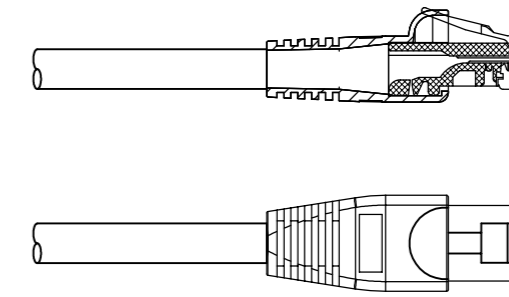

TABLE A

HL P/N	Customer P/N	LENGTH	Conductive resistance
HC.RJ455-0670	HA-C5S-30-BLU	[30ft] 9150±140mm	5 Ohm max.
HC.RJ455-0672	HA-C5S-35-BLU	[35ft] 10675±140mm	5 Ohm max.
HC.RJ455-0673	HA-C5S-40-BLU	[40ft] 12200±160mm	6 Ohm max.
HC.RJ455-0674	HA-C5S-50-BLU	[50ft] 115250±200mm	7 Ohm max.
HC.RJ455-0675	HA-C5S-60-BLU	[60ft] 18300±260mm	8 Ohm max.
HC.RJ455-0676	HA-C5S-75-BLU	[75ft] 22875±320mm	12 Ohm max.
HC.RJ455-0664	HA-C5S-100-BLU	[100ft] 30500±400mm	16 Ohm max.
HC.RJ455-0666	HA-C5S-150-BLU	[150ft] 45750±500mm	20 Ohm max.
HC.RJ455-0668	HA-C5S-200-BLU	[200ft] 61000±600mm	25 Ohm max.
HC.RJ455-0671	HA-C5S-300-BLU	[300ft] 91500±800mm	30 Ohm max.



Electrical character:

- 1)100% Open/short testing
- 2)Withstanding voltage:DC 200V AT 10ms.
AC 300V AT 10ms.
- 3)Insulation resistance:2M Ohm(min)
- 4)Conductive resistance:Table A.

Wire Details

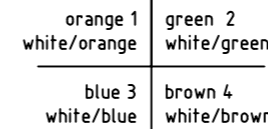
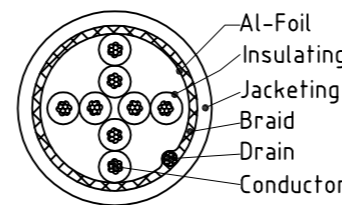

PIN ASSIGNMENT(568B):

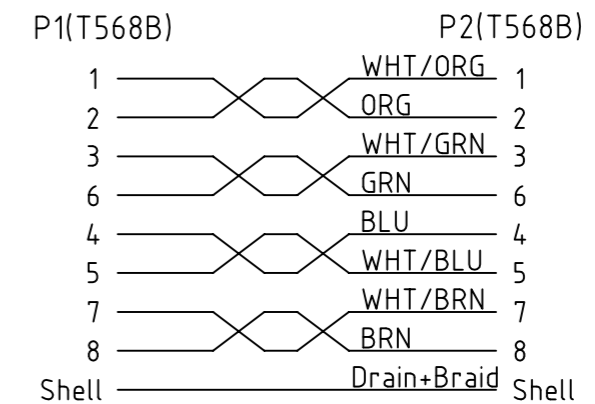

NO.	PART NAME	SPEC DESCRIPTION	PART P/N	REMARK
3	Hood	RJ45 Hood:PVC 70Pa,Blue	-----	
2	Conn	RJ45 Plug, Pin G/F,with Shell	-----	
1	Cable	Cat.5e STP 26AWG(7/0.16mm,CCA)×4P+A+D(7/0.16mm,CCA)+B(16/5/0.12mm,Al-Mg), Blue, OD5.5mm	-----	

Mould number:	Customer: M018UA	Customer P/N:	See table A	Article No./ HL-GC-001			
	Designed by: Pillar	Checked by:	Approved by	File number: D-xxxx	Date: 13/04/10	Scale: none	Unit: mm
				Name: Cat5e STP cable,Blue			
				P/N: HC.RJ455-xxxx(See Table A)		Edition: 1.0	Sheet: 1/3
Packing file: This drawing contains information that is proprietary to Hailink Electronics Limited incorporated and should not be used without written permission							