

Diagram 1-A

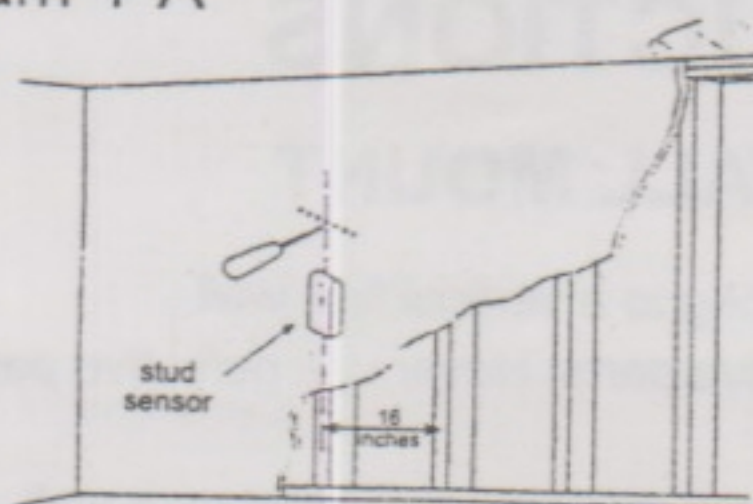
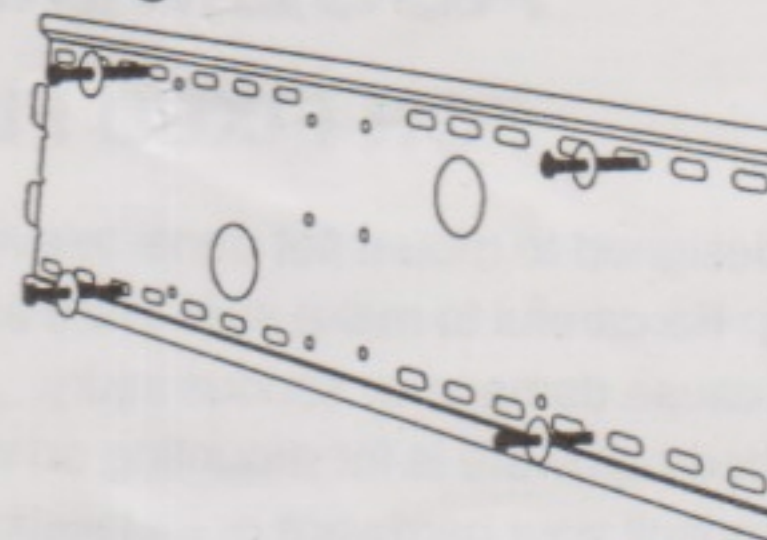
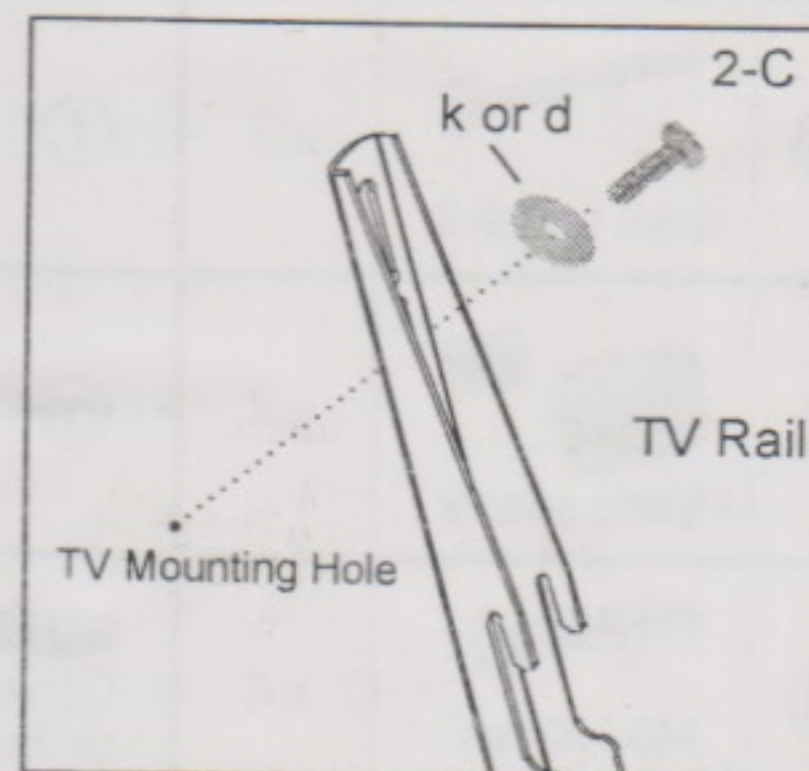
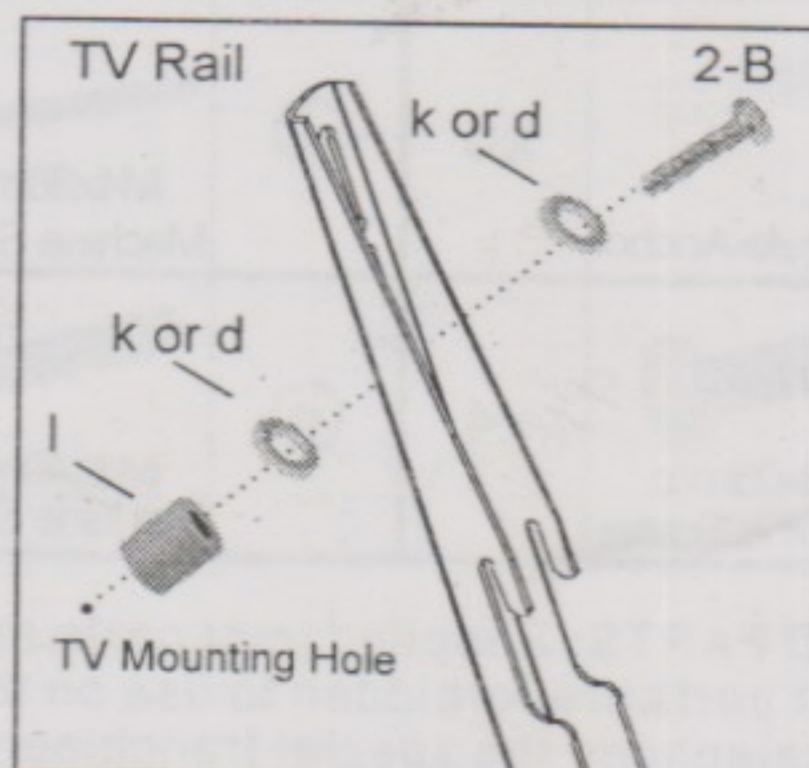
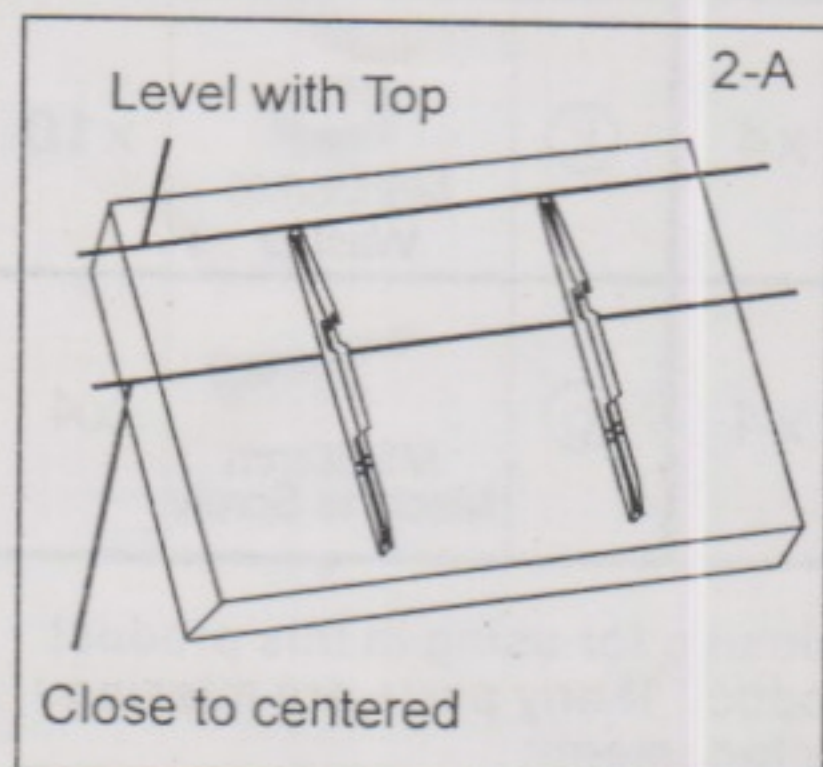

Diagram 1-B



② FIT SCREEN

2. MOUNT THE TV RAILS TO THE BACK OF YOUR FLAT PANEL TV: Make sure the TV Rails (b and c) are mounted at an equal distance from the top of the TV and as close to the center as possible as shown in diagram 2-A. Safety screws should face the outside of the television. M4, M5, M6 and M8 bolts are provided. Plastic Spacers (l) are provided for use with M4, M5, M6 and M8 TV mount bolts on TV's with curved or recessed back panels as shown in diagram 2-B. If you are mounting to a television with a flat back you will not need a plastic spacer as shown in diagram 2-C. **Make sure these bolts are right!** Some televisions have shallow threaded inserts; we have provided 4 extra washers you may use to offset this if the provided bolts are too long.



③ HANG ONTO THE WALL

3. HANG THE TV ONTO THE WALL PLATE:

First hook the TV Rails (b and c) over the top of the Wall

Plate (a) as showed in diagram 3-A.

Then tighten the Safety Screws as showed in diagram 4-B.

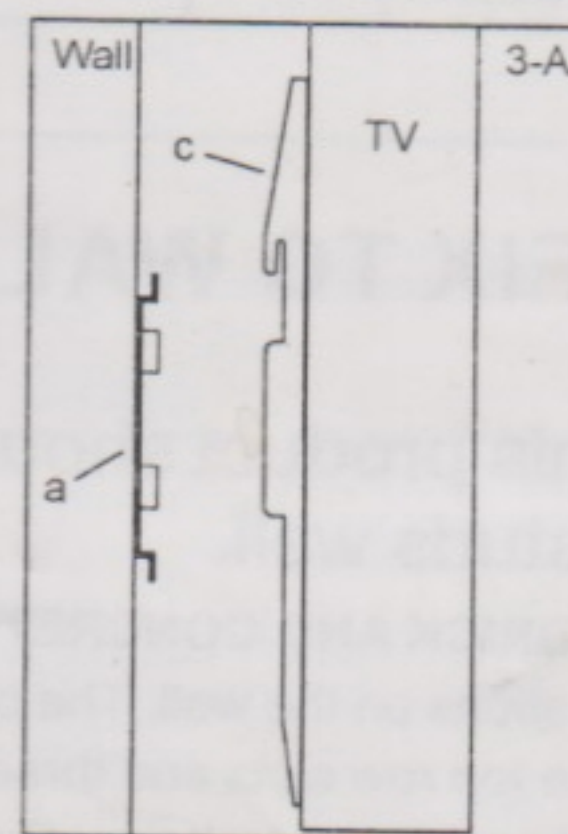
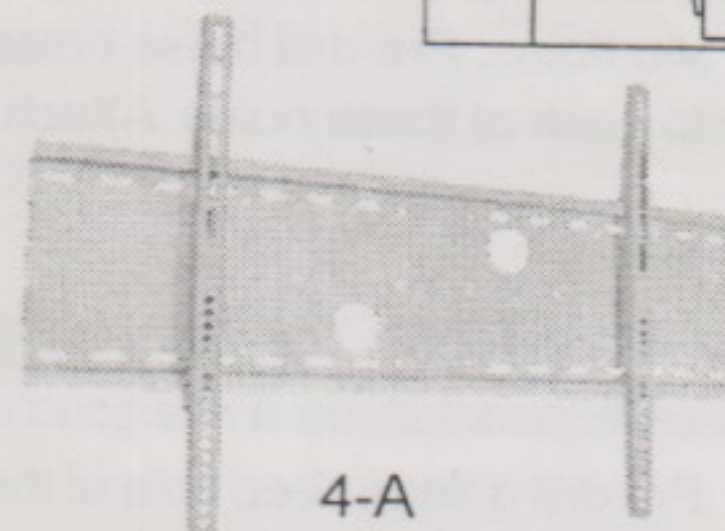
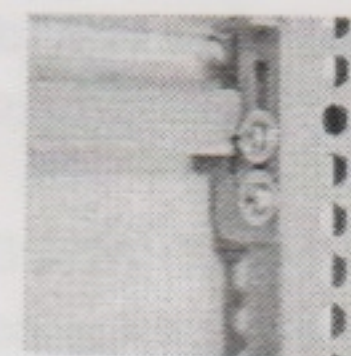

Diagram 4-A: Front view of the fixed plasma mount assembled.

Diagram 4-B: Safety screws tightened.



4-A



4-B

TENDING INSTRUCTION

Please check whether screws are fixed well each two months.

IF YOU HAVE ANY DOUBTS REGARDING INSTALLATION CONSULT OUR SPECIAL FRANCHISER.

ASSEMBLY INSTRUCTIONS













FOR FIXED FLAT PANEL WALL MOUNT

This product is designed to mount flat panel televisions weighing up to 75kg to a vertical firm wall.

Safety Warning: Be careful to make sure there are no missing or defective parts. Never use defective parts. Improper installation may cause damage or serious injury.

Note: The included hardware is for mounting on walls. If you are uncertain about the nature of your wall, consult an expert. Please consult your hardware or installation professional for proper mounting to other types or walls. The supplied hardware is not for steel.

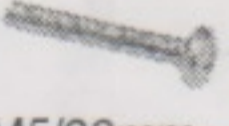
Forbidden Instruction: Do not mount onto plasterboard or paneled walls.

Ⓐ		x1	Ⓑ		x1	Ⓒ		x1	Ⓓ		x12
Ⓔ		x6	Ⓕ		x6	Ⓖ		x4	Ⓚ		x10
Ⓛ		x4	Ⓜ		x4	Ⓝ		x4	Ⓞ		x4
Ⓟ		x4	SUPPLIED PARTS: Supplied joint parts are exclusive for using in this product. Other joint parts are forbidden to use on this product. If any parts are missing or faulty, telephone the special franchiser for a placement.								

1 FIX TO WALL

Note: This product should be mounted to solid brick, concrete or hard wood batten/studs wall.

1a.SOLID BRICK AND CONCRETE BLOCK MOUNTING: Use the Wall Plate (a) as a template to mark 6 holes locations on the wall. The outer holes must fall to outside of the two large holes in the middle of the plate. Three in the top row slots and three more in the bottom row. Make sure these holes are level and there is at least 200mm between any two holes. Pre-drill these holes with a 10mm masonry bit to at least 60mm in depth. Insert a Concrete Anchor (f) into each of these holes. Attach the Wall Plate to the wall using 6 Lag Bolts (e) and 6 M4 / M5 / M6 Washers (d).

1b.HARD WOOD WALL MOUNTING: The Wall Plate (a) **MUST to be mounted to two wood studs.** Use a high quality stud sensor to locate three adjacent studs. It is a good idea to verify where the studs are located with an awl or thin nail shown in diagram 1-A. Pre-drill a 3mm deep hole at the desired height in each stud using a 4mm drill bit. Use the Wall Plate as a template to mark the location of the second hole in each stud. Pre-drill these holes using the 4mm drill bit as well. Attach the Wall Plate to the wall using the 4 Lag Bolts (e) and 4 M4 / M5 / M6 Washers (d). Make sure the Wall Plate is oriented so the flat surface in the center of the plate in against the wall shown in diagram 1-B.

Note: Do not use any concrete anchor when you mount the bracket onto hard wood wall.